



VYKON

by TRIDIUM

niagara
remote™

Features Overview

NIAGARA CLOUD APPLICATIONS

Cloud Backups
(Baseline & Scheduled)

niagara
recover™

Remote Engineering & Monitoring

niagara
remote™

More to Come

niagara
data service™

*next
service...*

- Contextualized Data
- Cloud Histories
- 3rd-Party App Access



Designed to simplify your
journey to the cloud

Designed for more secure
protection of your data

WHY NIAGARA REMOTE?

Niagara Remote helps increase productivity and savings for the busy Niagara Framework user that needs to:

- Troubleshoot a Niagara deployment
- Perform regular engineering and maintenance work on their Niagara station
- Access the Niagara UI to check the status of Niagara stations across a Niagara-based network

Payback measured
in fewer truck rolls!

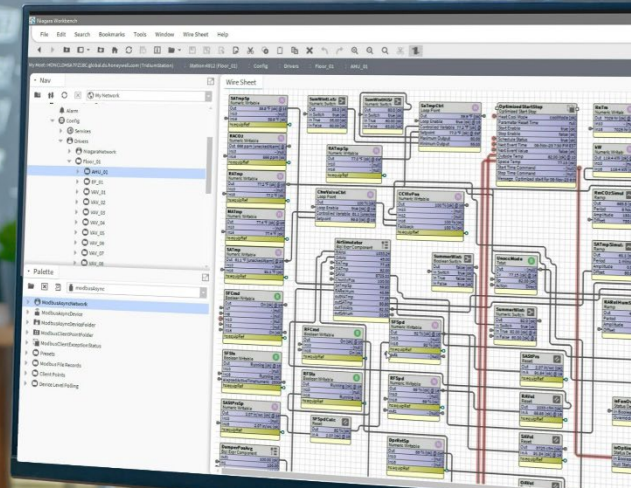

NIAGARA REMOTE

Niagara Remote™ provides web-based remote access to a Niagara station

- Log into a Niagara Supervisor or JACE remotely via browser
- No additional hardware, gateways or VPNs required!
- niagara cloud^{SUITE™} Management Portal

CONNECTING TO NIAGARA CLOUD SUITE

'Defense in Depth' Strategy:

Role-Based Data Access

Encryption via HTTPS

Chain of Trust via Certificate
Authentication

Multi-Factor
Authentication

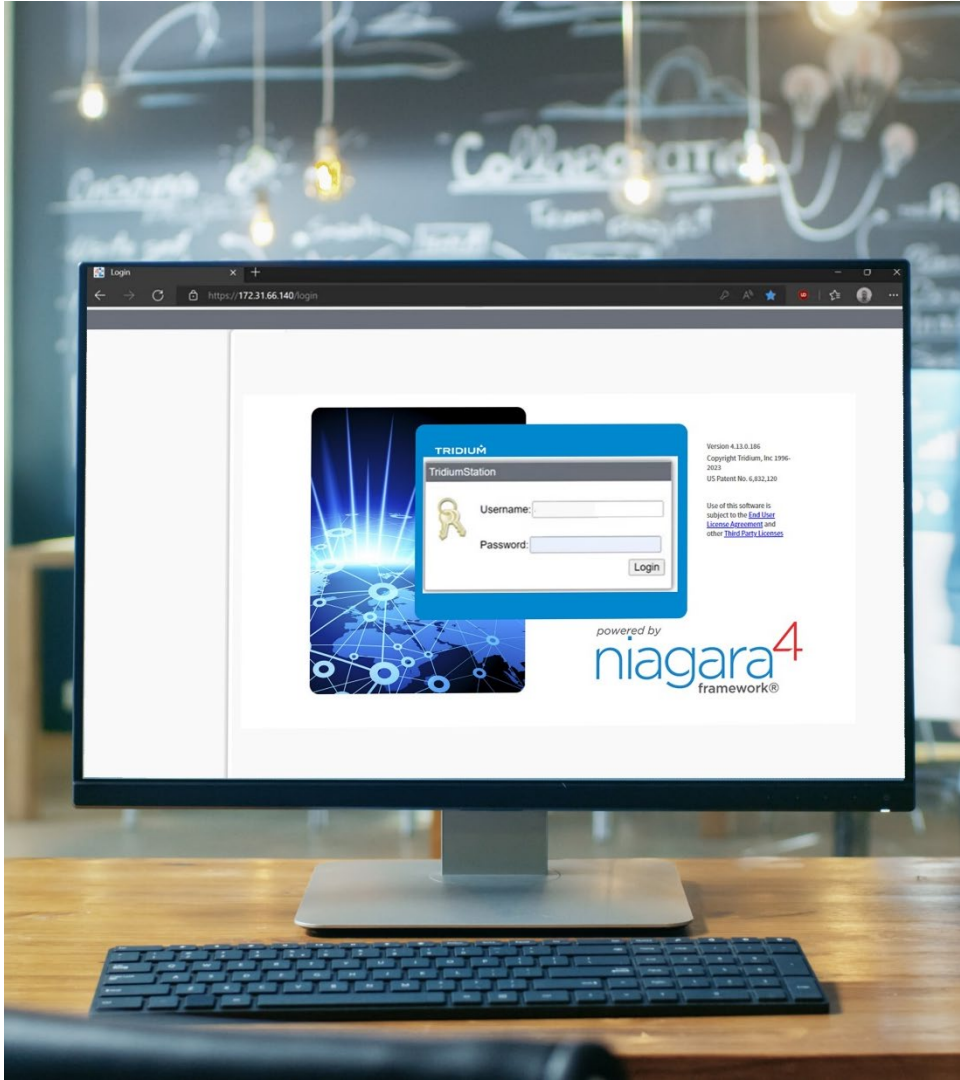

FEATURES

Remote Login
via browser

Direct
Connection;
No additional
VPN needed

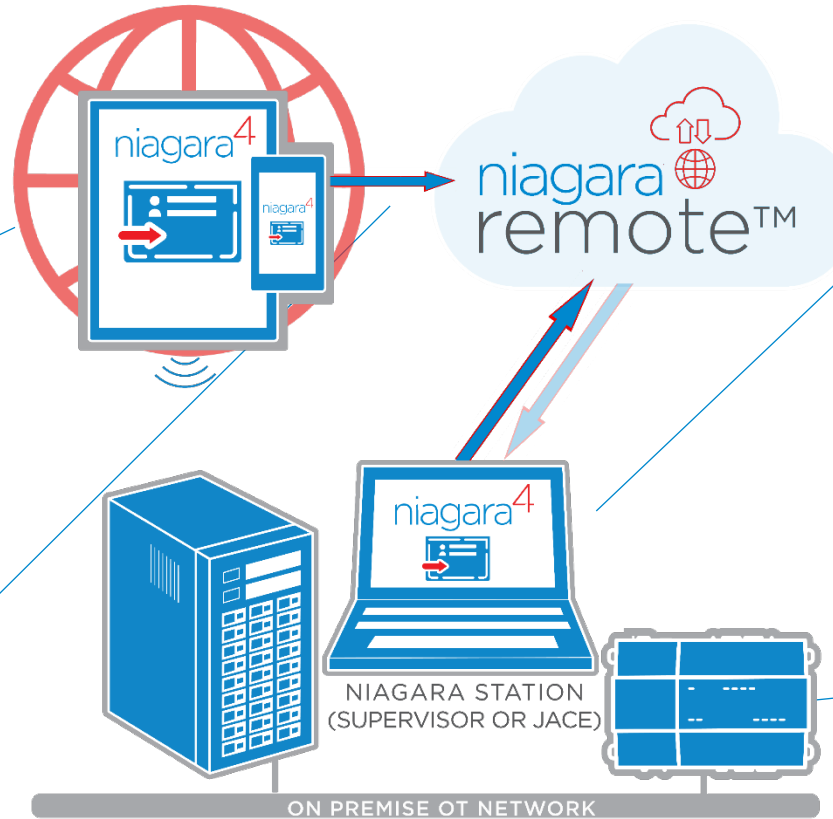

Authentication via
Niagara Cloud Suite™
Management Portal

All Niagara Defense-
in-Depth Features at
Supervisory and
JACE Levels

HOW NIAGARA REMOTE WORKS

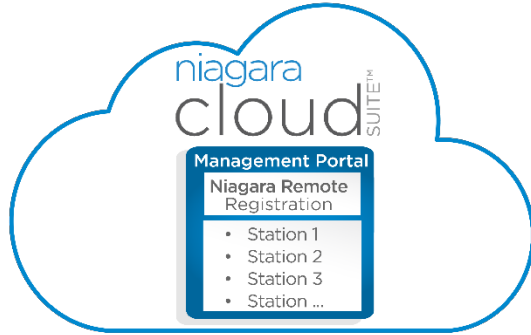

Registration: Subscribers register Niagara Supervisors and JACEs on Niagara Cloud Suite™ management portal.

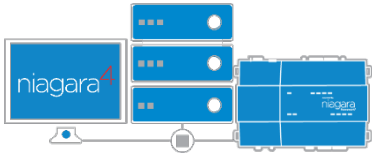

Connection: Registered stations create a secure, outbound WebSocket connection on port 443.



Log In: Remote users log into the Management Portal from browser. Upon successful authentication (including MFA), a remote access session is established over the station's WebSocket connection.

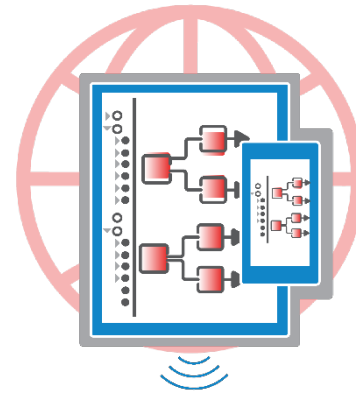

Work Remotely: Remote users can log on to Niagara Stations and do tasks inside Niagara applications, as if they were using an on-premises Niagara station. Web traffic is routed over WebSocket connection.



Log Out: Remote users log out from each Niagara station accessed during the remote session.

FIRST ONBOARDING

No Firewall Rules Required. Utilizes Outbound HTTPS.

The cloud service will make an outbound HTTPS request to begin onboarding. The cloud service will request a signed certificate via a certificate signing request.

Successful registration and authentication completes Niagara Cloud Onboarding process and results in a validated Client Certificate.

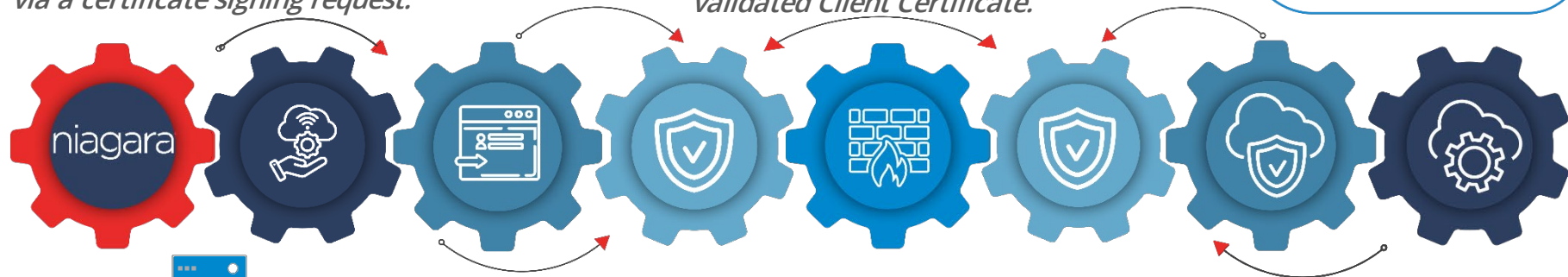

**ON-PREM JACE
or SUPERVISOR**

System Integrator authenticates using 2-factor. Selects the customer cloud tenant. Confirms subscription.

Niagara Cloud responds with registration URL, user code for authentication (30-min.)

Niagara Cloud responds by signing the requested certificate from the cloud service.

CONNECTING ON PREMISES

Once a Client Certificate is available, the Niagara Station cloud service can reestablish a conversation with Niagara Cloud at any time while that certificate is valid.

Randomly, approximately every 90 days, a new Client Certificate is created and rotated into the conversation.

Cloud service initiates session by requesting install of Client Certificate

Niagara Cloud validates device's Client Certificate



The cloud service establishes conversations based on the apps subscribed to: Niagara Remote , Niagara Recover , Niagara Data Service , and others to come.

Once validated, Niagara Cloud reestablishes connection

While connected, only the two endpoints — the Niagara Station device hosting the cloud service and its connection to Niagara Cloud — can decrypt the conversation between them.

CONNECTING REMOTELY



Via Web Browser, subscriber requests access to Niagara Cloud

HTTPS encrypted request

The Niagara Cloud User is authorized with 2-factor authentication, based on roles and access.

Niagara Cloud sets up a reverse proxy connection to the device

User enters their Niagara Credentials to access



niagara
cloud SUITE™

Annual subscription
per Niagara Station

NIAGARA REMOTE PRICING

Part Name	Description	Annual List Price
NCS-REMOTE-SUP	Supervisor-level subscription	\$4250 per station
NCS-REMOTE	Controller-Level subscription	

1. Requires Niagara instance to be covered by an active Software Maintenance Agreement (SMA) and to be running on a Niagara Framework Supported Version.
2. Niagara Reseller partner must sign the Addendum to Authorized Tridium Reseller Agreement for SaaS Offerings before they can purchase this service.



THANK YOU

To learn more about how to purchase and start using Niagara Remote™, please contact your account manager or Niagara partner.