



PIR Ready VT7600 Series Programmable & Non-Programmable Thermostats For Commercial HVAC Applications

September 1, 2010

Product overview

The VT7600 PI thermostat family is specifically designed for single stage and multi-stage control of heating/cooling equipment such as rooftop and self-contained units. The product features an intuitive, menu-driven, back-lit LCD display, which walks users through the programming steps, making the process extremely simple. Accurate temperature control is achieved due to the product's PI time proportional control algorithm, which virtually eliminates temperature offset associated with traditional, differential-based thermostats.

All models contain two digital inputs, which can be set by the user to monitor filter status, activate a remote temporary occupancy switch, and/or used as a general purpose service indicator. In addition, depending on the model, up to three remote sensor inputs are available. All models contain a SPST auxiliary switch, which can be used to control lighting or disable the economizer function and a discharge air sensor input. For more advanced applications, economizer control logic has been integrated onto the thermostat for use with proportional damper economizer actuators.



The thermostats are also compatible with the new Vykon PIR cover accessories. Thermostats equipped with a PIR cover provide advanced active occupancy logic, which will automatically switch occupancy levels from Occupied to Unoccupied as required by local activity being present or not. This advanced occupancy functionality provides advantageous energy savings during occupied hours without sacrificing occupant comfort. All thermostats can be ordered with or without a factory installed PIR cover (see ordering notes below).

The additional following documentation is available:

- VYKONStat PIR Application Guide
- VYKONStat PIR Cover Assembly Installation Guide
- VYKONStat PIR Ready VT76xx Series Thermostat BACnet Integration Guide
- VYKONStat PIR Ready VT7600 LonWorks Integration Guide
- VYKONStat Wireless Controller Application Guide

Models available

Application	1 Heat / 1 Cool	2 Heat / 2 Cool	2 Heat / 2 Cool with economizer	3 Heat / 2 Cool heat pump
Model (programmable)	VT7652A5x28(X)	VT7652B5x28(X)	VT7656B5x28(X)	VT7652H5x28(X)
Model (non-programmable)	VT7600A5x28(X)	VT7600B5x28(X)	VT7605B5x28(X)	VT7600H5x28(X)

Ordering Information Notes:

- (X) model number represents available communication options: X=none for Stand-alone, X=B for BACnet MS-TP, X=E for Echelon and X=W for Wireless
- Thermostats can be ordered with a factory installed PIR cover. Please use (5528) extension instead of the (5028) only extension.: Ex. VT7600B5528E.
- Thermostats ordered without a PIR cover can be retrofitted with a separate PIR accessory cover afterwards when required

Features and benefits

Features	Benefits
• Advanced occupancy functions	⇒ Through the network or smart local occupancy sensing
• Ready for PIR accessory cover	⇒ Fully integrated advanced occupancy functionality with a PIR accessory cover
• Ready for PIR accessory cover	⇒ Fully integrated advanced occupancy functionality with a PIR accessory cover
• 2 digital inputs	⇒ Adds functionality
• Smart fan operation	⇒ Saves energy during night mode
• Unique configuration key with password protection	⇒ Minimizes parameter tampering
• Lockable keypad	⇒ Tamper proof, no need for thermostat guards
• 6 hour reserve time for clock	⇒ No need to reprogram day/time after power shortage
• Remote room and outdoor temperature sensor	⇒ Increase flexibility and functionality
• Auxiliary output	⇒ Can be used for lighting and/or economizer override
• Discharge air sensor	⇒ Can be used to monitor unit efficiency
• Intuitive, menu-driven programming (7 day, 2/4 events - on programmable models only)	⇒ Can be used for all types of establishments
• Economizer output 0-10 Vdc economizer models only	⇒ Excellent retrofit opportunities

- 3 Heat/2 Cool (on heat pump models only)

⇒ Support single and two stages heat pump with one auxiliary heat stage

Theory of operation

The VT7600 uses a Vykon proprietary adaptive logic algorithm to control the space temperature. This algorithm controls the heating / air conditioning system to minimize overshoot while still providing comfort. It provides exceptional accuracy due to its unique PI time proportioning control algorithm, which virtually eliminates temperature offset associated with traditional, differential-based on/off thermostats.

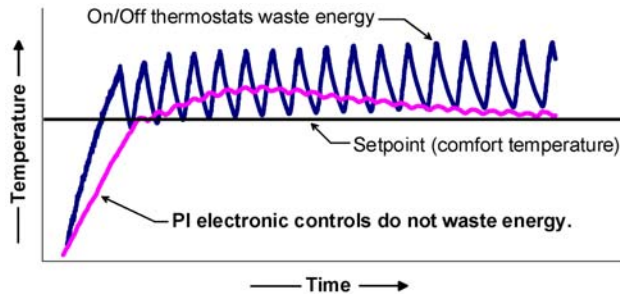

Fig.2 - On/Off mechanical control vs PI electronic control.

Features overview

- 7 day programmable models, 2 or 4 events
 - Gas/oil or electric system compatibility for all type of applications
 - Remote indoor averaging sensing capability
 - Temperature averaging with 2, 3, 4, 9 or 16 sensors
 - Remote outdoor sensing capability for added flexibility
 - System mode lock out
 - Heat pump balance point settings
 - Remote discharge air sensor input for monitoring purpose
 - System efficiency feedback
 - Lockable keypads for tamper proofing. No need for thermostat guards
 - Automatic frost protection to prevents costly freeze damage
 - Anti short cycle and minimum on/off run time protection. Reduces wear and maximizes life span of mechanical equipment.
 - 2 programmable digital inputs for added flexibility. Each input can be programmed as the following:
 - **None:** No function will be associated with the input
 - **Service:** a backlit flashing **Service** alarm will be displayed on the thermostat LCD screen when the input is energized. It can be tied in to the AC unit control card, which provides an alarm in case of malfunction.
 - **Filter:** a backlit flashing **Filter** alarm will be displayed on the thermostat LCD screen when the input is energized. It can be tied to a differential pressure switch that monitor filters
- Programmable smart fan operation saves energy during night mode
 - Non volatile EEPROM memory prevents loss of parameters during power shortage
 - Built in default profile set-up for easier start up and commissioning
 - Configurable SPST output relay on programmable models for lighting, exhaust fan or fresh air control
 - 6 hour typical reserve time for clock in case of power loss
 - 0 to 10 Vdc economizer output for more retrofit opportunities
 - Built in dry bulb economizer logic using outdoor temperature sensor
 - Input for supply/mixed air temperature sensor

Rem NSB: remote NSB timer clock input. Will disable the internal scheduling of the thermostat. The scheduling will now be set as per the digital input. The menu part related to scheduling is disabled and no longer accessible. It provides low cost setback operation via occupancy sensor or from a dry contact

- **RemOVR:** temporary occupancy contact. Disables all override menu function of the thermostat. . The override function is now controlled by a manual remote momentarily closed contact. When configured in this mode, the input operates in a toggle mode.

With this function enabled it is now possible to toggle between unoccupied & occupied setpoints for the amount of time set by parameter (TOccTime) temporary occupancy time.

- **Fan lock:** used in conjunction with a local air flow sensor connected to the input. Locks out the thermostat heating and cooling action and displays a local alarm if no air flow is detected 10 seconds after the fan (G terminal) is energized.

Heat pump model specific features

- Selectable single or dual stage compressor stages
- High balance point: Locks out auxiliary heating when outside air temperature is above this value
- Low balance point: Locks out heat pump compressor operation when outside air temperature is below this value
- Comfort/economy mode: In economy mode, heat pump use is maximized before turning On auxiliary heating
- Compressor/auxiliary interlock: Adds flexibility by locking out heat pump operation during auxiliary heating to prevent high pressure trip when the coil is downstream of the auxiliary heat source.

Installation

- Remove security screw on the bottom of thermostat cover.
- Open up by pulling on the bottom side of thermostat.
- Remove Assembly and remove wiring terminals from sticker. **(Fig. 3)**
- Please note the FCC ID and IC label installed in the cover upon removal of cover for the wireless products.

A) Location:

- 1- Should not be installed on an outside wall.
- 2- Must be installed away from any heat source.
- 3- Should not be installed near an air discharge grill.
- 4- Should not be affected by direct sun radiation.
- 5- Nothing must restrain vertical air circulation to the thermostat.

B) Installation:

- 1- Swing open the thermostat PCB to the left by pressing the PCB locking tabs. **(Fig. 4)**
- 2- Pull out cables 6" out of the wall.
- 3- Wall surface must be flat and clean.
- 4- Insert cable in the central hole of the base.
- 5- Align the base and mark the location of the two mounting holes on the wall. Install proper side of base up.
- 6- Install anchors in the wall.
- 7- Insert screws in mounting holes on each side of the base. **(Fig. 4)**
- 8- Gently swing back the circuit board on the base and push on it until the tabs lock it.
- 10- Strip each wire 1/4 inch.
- 11- Insert each wire according to wiring diagram.
- 13- Gently push back into hole excess wiring **(Fig. 5)**
- 14- Re-Install wiring terminals in correct location. **(Fig. 5)**
- 15- Reinstall the cover (top side first) and gently push back extra wire length into the hole in the wall.
- 16- Install security screw.



- If replacing an old thermostat, label the wires before removal of the old thermostat.
- Electronic controls are static sensitive devices. Discharge yourself properly before manipulation and installing the thermostat.
- Short circuit or wrong wiring may permanently damage the thermostat or the equipment.
- Anti-short cycling can be set to 0 minutes for equipment that posses their own anti cycling timer. Do not use that value unless the equipment is equipped with such internal timer. Failure to do so can damage the equipment.
- All VT7600 series thermostats are to be used only as operating controls. Whenever a control failure could lead to personal injury and/or loss of property, it becomes the responsibility of the user to add safety devices and/or alarm system to protect against such catastrophic failures.

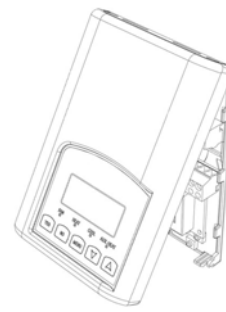

Fig.3

Location of PCB retaining tabs

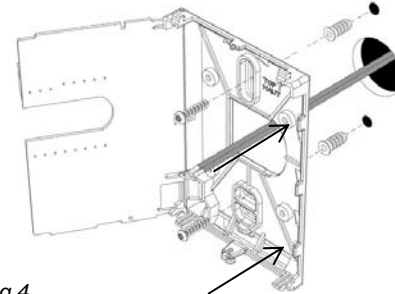

Fig.4

Re-install terminal blocks

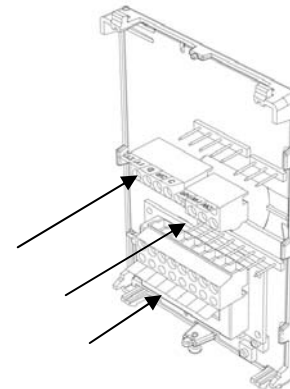

Fig.5

Thermostat assembly
(VT7600B5x28 shown)



Fig.6

Wiring identification & screw terminal arrangement

Part Number	Multistage				1H / 1C		Part Number	Heat Pump	
	VT7656B	VT7605B	VT7652B	VT7600B	VT7652A	VT7600A		VT7652H	VT7600H
Programmable	Yes	No	Yes	No	Yes	No	Programmable	Yes	No
Top left terminal block							Top left terminal block		
Y2	X	X	X	X			Y2	X	X
Y1	X	X	X	X	X	X	Y1	X	X
G	X	X	X	X	X	X	G	X	X
RC	X	X	X	X	X	X	RC	X	X
C	X	X	X	X	X	X	C	X	X
Top right terminal block							Top right terminal block		
RH	X	X	X	X	X	X	RH	X	X
W1	X	X	X	X	X	X	W1	X	X
W2	X	X	X	X			O/B	X	X
Bottom terminal block							Bottom terminal block		
Econo	X	X							
Aux	X	X	X	X	X	X	Aux	X	X
DI1	X	X	X	X	X	X	DI1	X	X
DI2	X	X	X	X	X	X	DI2	X	X
RS	X	X	X	X	X	X	RS	X	X
Scom	X	X	X	X	X	X	Scom	X	X
OS	X	X	X	X	X	X	OS	X	X
MS	X	X	X	X	X	X	MS	X	X

Screw terminal arrangement

5 pole left top connector



3 pole left top connector

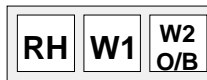

8 pole bottom connector

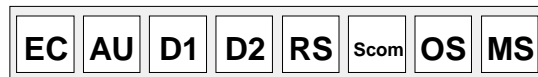

Wiring notes:

Note 1: If the same power source is used for the heating stages, install jumper across RC & RH. Maximum current is 2.0 amps.

Note 2: If auxiliary output is used to toggle occupancy of the electronic control card inside the equipment, configure the relay parameter (Aux cont) to the N.O. setting. A second relay can be added for additional functionality of the occupancy output.

Note 3: Economizer output uses a half bridge rectifier. Reference of the control signal is the common of the power supply of the thermostat. (terminal C)

Note 4: Electromechanical contacts are to be used with the digital inputs. Electronic triacs cannot be used as mean of switching for the input. The switched leg to the input for the input to activate is terminal C (common)

Note 5: The transformer of the unit provides power to the thermostat and the additional loads that will be wired to the thermostat.

VT7656B5X28(X)
2 Heat / 2 Cool / Economizer / Programmable

Thermostat Terminals -VT7656B5x00

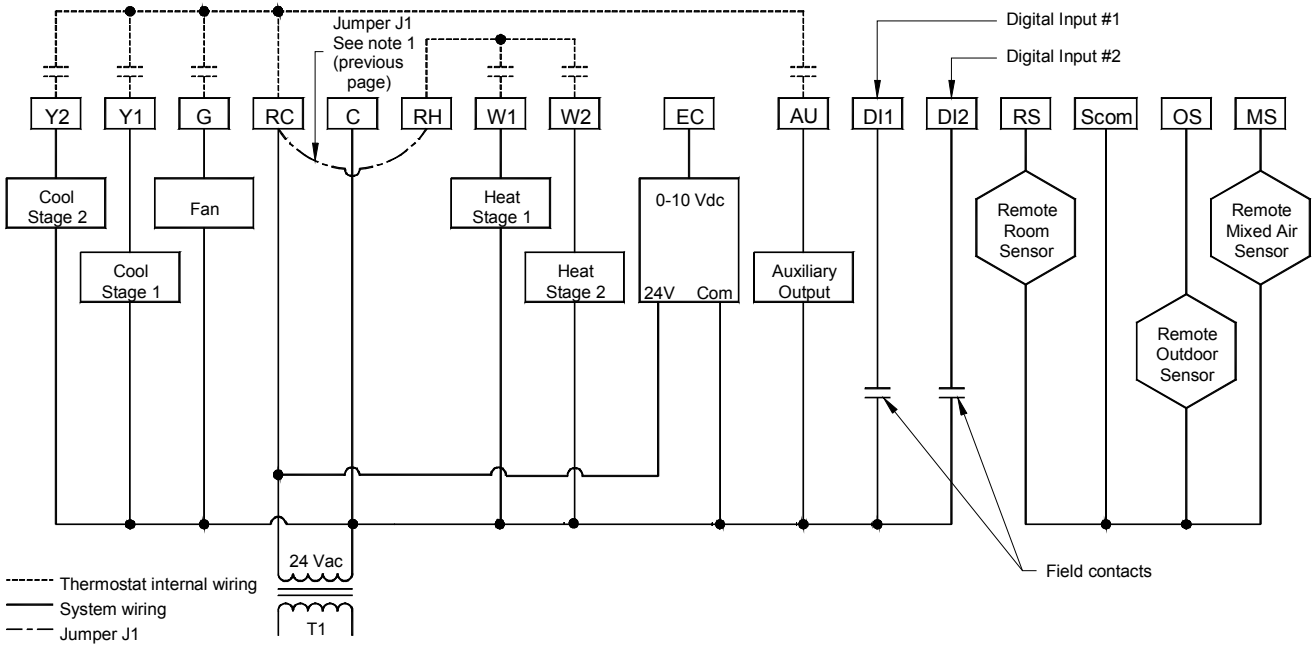
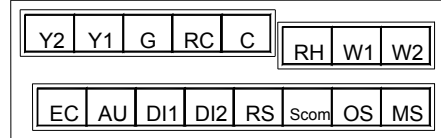

VT7652H5X28(X)
Heat pump / Programmable

Thermostat Terminals -VT7652H5x00

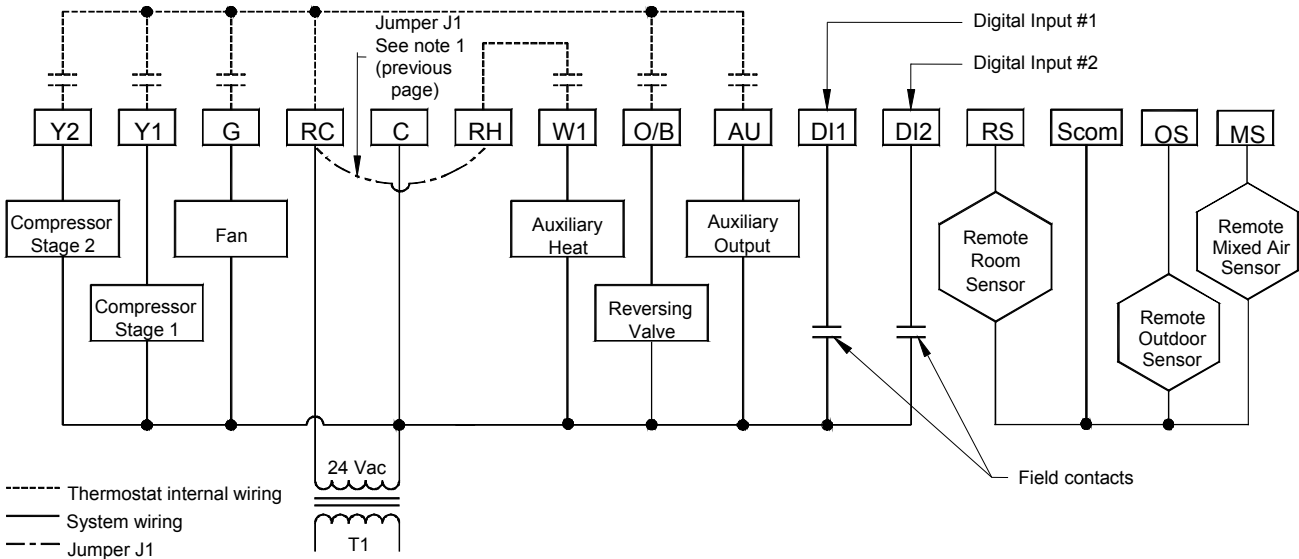
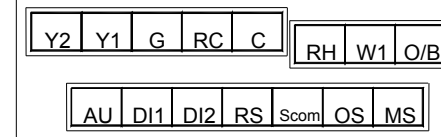

Remote sensor accessories

Model no.	Description
S3010W1028	Wall mounted temperature sensor
S3020W1028	Wall mounted temperature sensor with override button and occupancy status LED
S2020E1028	Outdoor temperature sensor
S2060A1028	Averaging temperature sensor
S2000D1028	Duct mounted temperature sensor



Fig.8 – S3020W1028 wall mounted sensor

Remote mount temperature sensors use 10K NTC thermistors.

- This sensor can be used for:
- 3 thermistors with 2 dip switches are provided with each sensor for various averaging combinations
- Optional occupancy led
- Optional override key

Wiring example of single remote room sensor:

VT7600 Series Thermostat 1x S3020W1028 Remote wiring 1 sensor S2-1 = ON / S2-2 = ON

S3010W1028 Remote wiring 1 sensor S2-1 = ON / S2-2 = ON

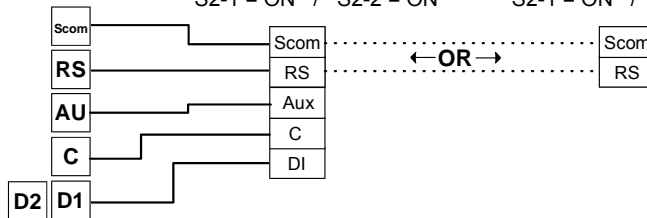

Dip switch setting for: **1 sensor**

ON S2-1 = ON
OFF S2-2 = ON

Wiring examples of 2 remote room sensors for averaging applications:

VT7600 Series Thermostat 2x S3020W1028 Remote wiring 2 sensors S2-1 = OFF / S2-2 = ON

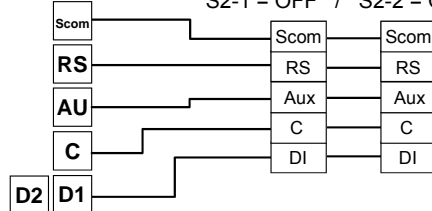

VT7600 Series Thermostat 2x S3010W1028 Remote wiring 2 sensors S2-1 = OFF / S2-2 = ON

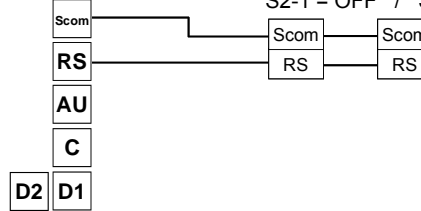

VT7600 Series Thermostat 1x S3010W1028 and 1x S3020W1028 Remote wiring 2 sensors S2-1 = OFF / S2-2 = ON

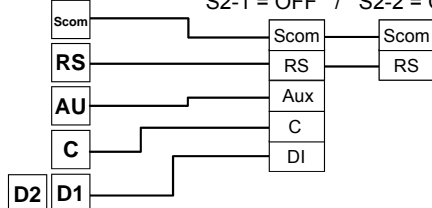

Notes for averaging applications:

- S3010W1028 and S3020W1028 can be mixed matched.
- S3010W1028 and S3020W1028 are to be wired in parallel.
- Respect the dip switch setting in each remote sensor.

Dip switch setting for: **2 sensors**

ON S2-1 = OFF
OFF S2-2 = ON

Wiring examples of 3 remote room sensors for averaging applications:

VT7600 Series Thermostat 2x S3010W1028 and 1x S3020W1028 Remote wiring 3 sensors S2-1 = OFF / S2-2 = OFF

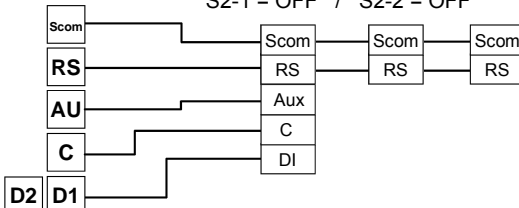

VT7600 Series Thermostat 1x S3010W1028 and 2x S3020W1028 Remote wiring 3 sensors S2-1 = OFF / S2-2 = OFF

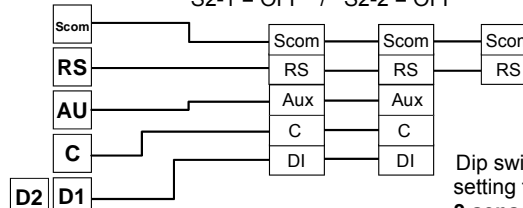

Dip switch setting for: **3 sensors**

ON S2-1 = OFF
OFF S2-2 = OFF

Temperature vs resistance chart for 10 Kohm NTC thermistor

($R_{25^{\circ}\text{C}} = 10\text{K}\Omega \pm 3\%$ - $B_{25/85^{\circ}\text{C}} = 3975\text{K} \pm 1.5\%$)

°C	°F	Kohm	°C	°F	Kohm	°C	°F	Kohm	°C	°F	Kohm	°C	°F	Kohm
-40	-40	324.3197	-20	-4	94.5149	0	32	32.1910	20	68	12.4601	40	104	5.3467
-39	-38	303.6427	-19	-2	89.2521	1	34	30.6120	21	70	11.9177	41	106	5.1373
-38	-36	284.4189	-18	0	84.3147	2	36	29.1197	22	72	11.4018	42	108	4.9373
-37	-35	266.5373	-17	1	79.6808	3	37	27.7088	23	73	10.9112	43	109	4.7460
-36	-33	249.8958	-16	3	75.3299	4	39	26.3744	24	75	10.4443	44	111	4.5631
-35	-31	234.4009	-15	5	71.2430	5	41	25.1119	25	77	10.0000	45	113	4.3881
-34	-29	219.9666	-14	7	67.4028	6	43	23.9172	26	79	9.5754	46	115	4.2208
-33	-27	206.5140	-13	9	63.7928	7	45	22.7861	27	81	9.1711	47	117	4.0607
-32	-26	193.9703	-12	10	60.3980	8	46	21.7151	28	82	8.7860	48	118	3.9074
-31	-24	182.2686	-11	12	57.2044	9	48	20.7004	29	84	8.4190	49	120	3.7607
-30	-22	171.3474	-10	14	54.1988	10	50	19.7390	30	86	8.0694	50	122	3.6202
-29	-20	161.1499	-9	16	51.3692	11	52	18.8277	31	88	7.7360	51	124	3.4857
-28	-18	151.6239	-8	18	48.7042	12	54	17.9636	32	90	7.4182	52	126	3.3568
-27	-17	142.7211	-7	19	46.1933	13	55	17.1440	33	91	7.1150	53	127	3.2333
-26	-15	134.3971	-6	21	43.8268	14	57	16.3665	34	93	6.8259	54	129	3.1150
-25	-13	126.6109	-5	23	41.5956	15	59	15.6286	35	95	6.5499	55	131	3.0016
-24	-11	119.3244	-4	25	39.4921	16	61	14.9280	36	97	6.2866	56	133	2.8928
-23	-9	112.5028	-3	27	37.5056	17	63	14.2629	37	99	6.0351	57	135	2.7886
-22	-8	106.1135	-2	28	35.6316	18	64	13.6310	38	100	5.7950	58	136	2.6886
-21	-6	100.1268	-1	30	33.8622	19	66	13.0307	39	102	5.5657	59	138	2.5926

S3010W1028 remote wall mounted temperature sensor, dip switch location

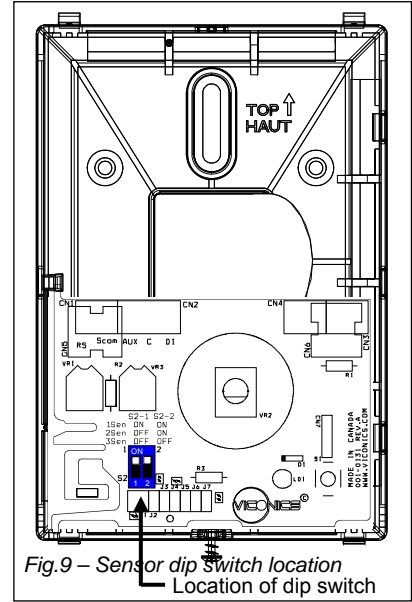

S2000D1028, remote duct mounted temperature sensor c/w junction box.

This sensor can be used for:

- Remote return air temperature sensing with the sensor mounted on the return air duct.
- Outside air temperature sensing with the sensor installed in the fresh air plenum.
- Supply air temperature sensor

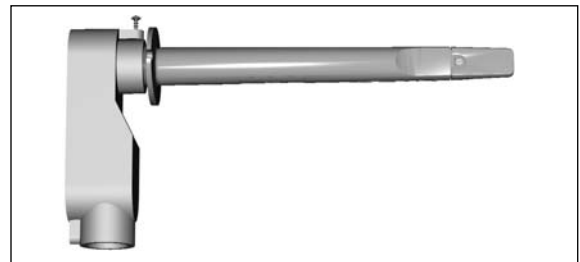

Fig.10 – Remote duct mounted temperature sensor

S2060A1028, remote averaging duct mounted temperature sensor c/w junction box.

This sensor can be used for:

- Remote averaging return air temperature sensing with the sensor mounted on the return air duct.
- Outside air temperature averaging sensing with the sensor installed in the fresh air plenum.
- Mixed air temperature averaging sensor for economizer models with the sensor in the mixing plenum.

S2020E1028, outdoor air temperature sensor

This sensor can be used for:

- Outside air temperature sensing with the sensor installed directly exposed to the elements.
- Sensor uses a water resistant NEMA 4 ABS enclosure for outdoor applications

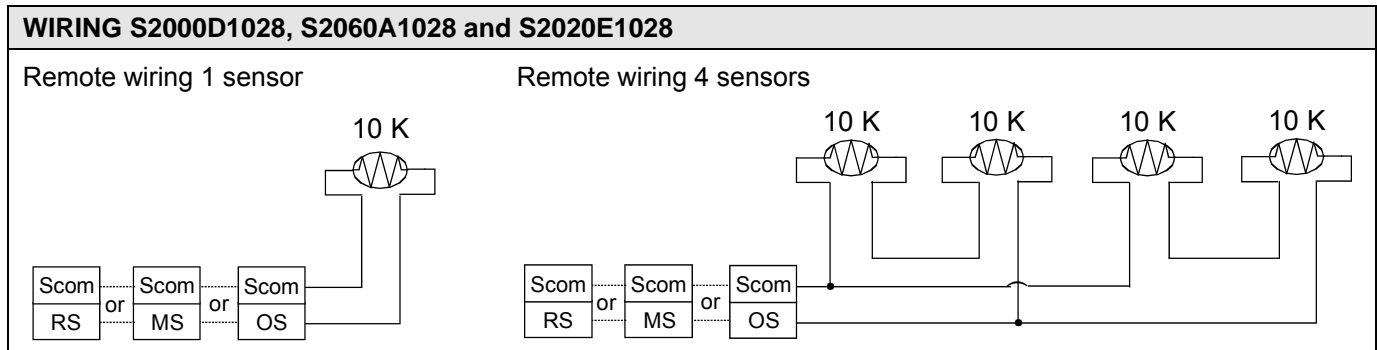

User menu flow chart:

NOTE: Prompts may not all be present depending on model selected

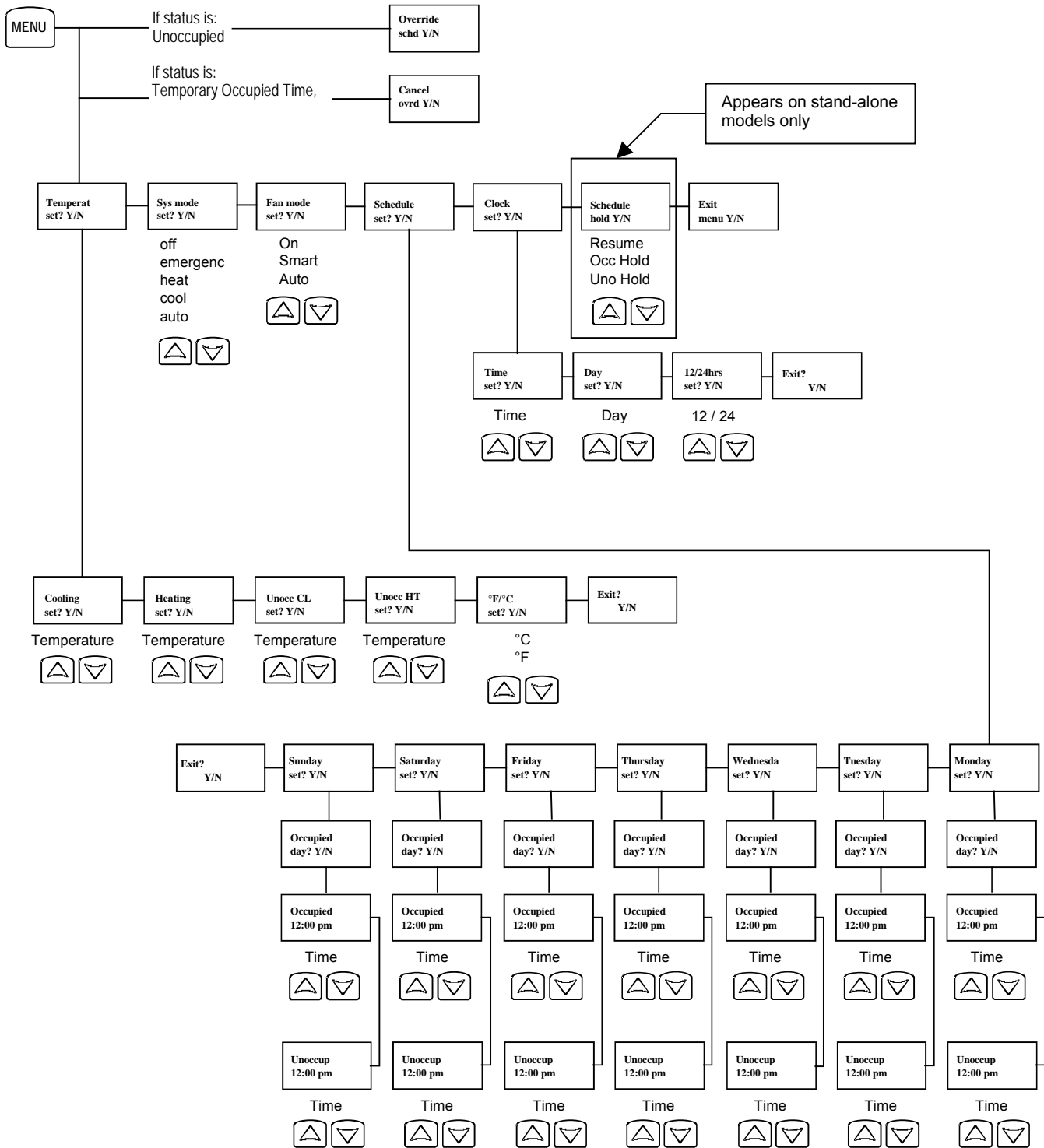

Programming and status display instructions

1. Status display

The thermostat features a two-line, eight-character display. There is a low level back-light level that is always active and can only be seen at night. When left unattended, the thermostat has an auto scrolling display that shows the actual status of the system. Each item is scrolled one by one with the back lighting off. Pressing any key will cause the back light to come on.

Sequence of auto-scroll status display:

Room temperature	Clock status	System mode	Schedule status	Outdoor temperature	Alarms
RoomTemp x.x °C or °F	Monday 12.00 AM	Sys mode auto	Occupied	Outdoor x.x °C or °F	Service
		Sys mode off	Occupied hold		Frost ON
		Sys mode heat	Unoccup		SetClock
		Sys mode cool	Unoccup hold		Filter
		Sys mode emergenc	Override		Fan lock

Manual scroll of each menu item is achieved by pressing the Yes (scroll) key repetitively. The last item viewed will be shown on the display for 30 seconds before returning to automatic scrolling. Temperature is automatically updated when scrolling is held.

Outdoor air temperature display is only enabled when outdoor air temperature sensor is connected.

- A maximum range status display of 50 °C (122 °F) indicates a shorted sensor. Associated functions, such as mode lockouts and economizer function are automatically disabled.
- A minimum range status -40 °C (-40 °F) is not displayed and indicates a opened sensor or a sensor not connected. Associated functions, such as mode lockouts and economizer function are automatically disabled.

If alarms are detected, they will automatically be displayed at the end of the status display scroll. During an alarm message display, the back lit screen will light up at the same time as the message and shut off during the rest of the status display. Two alarms maximum can appear at any given time. The priority for the alarms is as follows:

Frost ON	Indicates that the heating is energized by the low limit frost protection room temperature setpoint 5.6 °C (42 °F)
SetClock	Indicates that the clock needs to be reset. There has been a power failure which has lasted longer than 6 hours
Service	Indicates that there is a service alarm as per one of the programmable digital input (D11 or D12)
Filter	Indicates that the filters are dirty as per one of the programmable digital input (D11 or D12)
Fan lock	Indicates that the heating and cooling action are locked out due to a defective fan operation

Three status LEDs on the thermostat cover are used to indicate the status of the fan, a call for heat, or a call for cooling.

LED operation	Heatpump models VT76xxH	Multistage and single stage models VT7600A, VT7652A, VT7600B & VT7652B	Multistage economizer models VT7605B & VT7656B
Fan LED on	When G Fan terminal operates	When G Fan terminal operates	When G Fan terminal operates
Heating LED on	When Y1 and / or W1 terminal(s) operate in heating mode	When W1 terminal operate in heating mode	When W1 terminal operate in heating mode
Cooling LED on	When Y1 terminal operate in cooling mode	When Y1 terminal operate in cooling mode	When Y1 terminal operate in cooling mode and or economizer output is in function

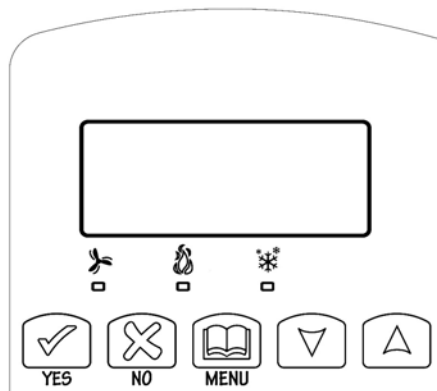

Fig. 11 – Heatpump, multistage and single stage models

2. User programming instructions menu

The VT7600 series of thermostat feature an intuitive, menu-driven, back-lit LCD display that walks users through the programming steps, making the programming process extremely simple. This menu is typically accessed by the user to set the parameters such as temperature and time events, system mode, fan mode, etc.

It is possible to bring up the user menu at any time by depressing the MENU key. The status display automatically resumes after exiting the user-programming menu.

If the user pauses at any given time during programming, **Auto Help** text is displayed to help and guide the user through the usage and programming of the thermostat.

Ex.: Press yes key to change cooling temperature setpoint
Use the up or down arrow to adjust cooling setpoint

Each of the sections in the menu are accessed and programmed using 5 keys on the thermostat cover. The priority for the alarms is as follows:

 The YES key is used to confirm a selection, to move onto the next menu item and to manually scroll through the displayed information.
SCROLL

 The NO key is used when you do not desire a parameter change, and to advance to the next menu item. Can also be used to toggle between heating and cooling setpoints.

 The MENU key is used to access the Main User Menu or exit the menu.

 The down arrow key is used to decrease temperature setpoint and to adjust the desired values when programming and configuring the thermostat.

 The up arrow key is used to increase temperature setpoint and to adjust the desired values when programming and configuring the thermostat.

When left unattended for 45 seconds, the display will resume automatic status display scrolling. To turn on the back light, press any key on the front panel. The back lit display will turn off when the thermostat is left unattended for 45 seconds

Sequence of user menu:

Override Resume	Temperature setpoints	System mode setting	Fan mode setting	Schedules setting	Clock setting	Schedule hold
Override schd Y/N	Temperat set Y/N	Sys mode set Y/N	Fan mode set Y/N	Schedule set Y/N	Clock set Y/N	Schedule hold Y/N
Appears only in unoccupied mode						Appears only on stand-alone models
Cancel ovrd Y/N						
Appears only in override mode						

There is a default profile set in the thermostat from the factory. This enables the thermostat to operate as a non-programmable unit in day mode operation at start up.

Programmed default temperature setpoints:
Occupied cooling setpoint = 24 °C (75 °F)
Occupied heating setpoint = 22 °C (72 °F)
Unoccupied cooling setpoint = 28 °C (82 °F)
Unoccupied heating setpoint = 18 °C (65 °F)
Fahrenheit scale
Setpoint type = permanent

Programmed default modes:
System mode = Auto
Fan mode = Smart (for models with a communication module or programmable stand-alone models) Fan mode = Auto (for non-programmable stand-alone models)
Programmed default schedules:
Monday through Sunday
Occupied time is: 12 00 AM
Unoccupied time is: 11:59 PM

There will be a 1 minute unoccupied period every night at 11:59 PM with this default configuration.

A) Override an unoccupied period

Override
schd Y/N

This menu will appear only when the thermostat is in unoccupied mode. The unoccupied mode is enabled either by the internal timer scheduling or by a remote NSB contact via DI1 or DI2.

If DI1 or DI2 is configured to operate as a remote temporary override contact, this menu will be disabled.

Answering yes to this prompt will cause the thermostat to go into occupied mode for an amount of time equal to the parameter "TOccTime" (1 to 12 hours).

B) Resume regular scheduling

Cancel
ovrd Y/N

This menu does not appear in regular operation. It will appear only when the thermostat is in Unoccupied override mode.

Answering "Yes" to this question will cause the thermostat to resume the regular programmed setpoints & scheduling.

C) Temperature setpoints

Permanent setpoint changes

Temperat
set Y/N

This menu permits the adjustment of all permanent temperature setpoints (occupied and unoccupied) as well as the desired temperature units (°F or °C). Permanent setpoints are written to RAM and EEPROM

Cooling setpoint Occupied mode		Heating setpoint Occupied mode		Cooling setpoint Unoccupied mode		Heating setpoint Unoccupied mode		°F or °C display setting	
Cooling set? Y/N	No next → Yes down ↓	Heating set? Y/N	No next → Yes down ↓	Unocc CL set? Y/N	No next → Yes down ↓	Unocc HT set? Y/N	No next → Yes down ↓	°F or °C set? Y/N	No next → Yes down ↓
Use ▲▼ keys to set value, Yes key to confirm									
Cooling 70.0 °F	Use ▲▼ To set value	Heating 68.00 °F	Use ▲▼ To set value	Unocc CL 80.0 °F	Use ▲▼ To set value	Unocc HT 60.0 °F	Use ▲▼ To set value	Units °F	Use ▲▼ To set value

Temporary setpoint changes

Temporary setpoints can be modified through the Up arrow key (▲) and the Down arrow keys (▼).

User will be prompted with the present mode (Heating or Cooling) of the thermostat and its setpoint.

The Up (▲) arrow key will increment the setpoint by 0.5 degree (F or C).

The Down (▼) arrow key will decrement the setpoint by 0.5 degree (F or C).

Press the Yes key to accept the new setpoint.

Local changes to the heating or cooling setpoints made by the user directly using the up or down arrow are temporary.

They will remain effective for the duration specified by ToccTime.

Setpoints will revert back to their default value after internal timer ToccTime expires.

If a permanent change to the setpoints is required, use the **Temperat set ?** menu

D) System mode setting

Sys mode
set Y/N

This menu is accessed to set system mode operation

Use ▲▼ to set value, Yes key to confirm

Sys mode auto	Automatic mode Automatic changeover mode between heating and cooling operation
Sys mode cooling	Cooling mode Cooling operation mode only
Sys mode heating	Heating mode Heating operation mode only
Sys mode emergency	Emergency heat mode (heat pump models only) Forced auxiliary heat operation mode only
Sys mode off	Off mode Normal cooling or heating operation disabled If enabled in installer parameters, only the automatic heating frost protection at 50 °F (10 °C) is enabled

E) Fan mode setting

Fan mode set Y/N

This section of the menu is permits the setting of the fan mode operation. Use ▲▼ to set value, Yes key to confirm

Fan mode On	On fan mode Fan is on continuously, even when system mode is OFF.
Fan mode Auto	Automatic fan mode Fan cycles on a call for heating or cooling for both occupied & unoccupied periods.
Fan mode Smart	Smart fan mode During occupied periods, fan is on continuously. In unoccupied mode, fan cycles on a call for heating or cooling. This selection is available on all models with a communication module, on all stand-alone programmable models or if DI1 or DI2 is set to RemNSB on stand-alone non-programmable models

F) Schedule set (2 events)

Scheduling can have 2 or 4 events per day. This is set in the configuration menu as per parameter (2/4event)

Schedule set Y/N

This section of the menu permits the user to set the whether 2 or 4 events is needed. Each day can be tailored to specific schedules if needed.

- 2 events can be programmed per day.
- Occupied & unoccupied periods can be set for each day.

Monday timer Schedule set		Tuesday timer Schedule set		Wednesday timer Schedule set		Other days are identical
Monday set? Y/N	No next → Yes down ↓	Tuesday set? Y/N	No next → Yes down ↓	Wednesday set? Y/N	No next → Yes down ↓	Selects the day to be programmed or modified
Yes key to access day scheduling, No key to jump to next day						
Occupied Day? Y/N	No next → Yes down ↓	Occupied Day? Y/N	No next → Yes down ↓	Occupied Day? Y/N	No next → Yes down ↓	Yes = Daily schedules will be accessed No = Unoccupied mode all day
Yes key to access day scheduling, No key to jump to next day						
		Copy Y/N Previous	Yes next → No down ↓	Copy Y/N Previous	Yes next → No down ↓	Yes = Will copy previous day schedule No = Daily schedules will be accessed
Yes key to copy previous day, No key to set new time value for each day						
Occupied 00:00 AM	Use ▲▼ To set value	Occupied 00:00 AM	Use ▲▼ To set value	Occupied 00:00 AM	Use ▲▼ To set value	Sets Event # 1 Occupied time Will activate occupied setpoints
Use ▲▼ to set value, Yes key to confirm						
Unoccup 00:00 AM	Use ▲▼ To set value	Unoccup 00:00 AM	Use ▲▼ To set value	Unoccup 00:00 AM	Use ▲▼ To set value	Sets Event # 2 Unoccupied time Will activate unoccupied setpoints
Use ▲▼ to set value, Yes key to confirm						

Typical examples of a 2 event office schedule

Ex. #1 Office building closed all weekend

Event	Period #1 - Event #1		Period #1 - Event #2	
	Occupied		Unoccupied	
Setpoint	Cool 72 °F	Heat 70 °F	Cool 80 °F	Heat 62 °F
Monday	7.00 AM		6.00 PM	
Tuesday	7.00 AM		6.00 PM	
Wednesday	7.00 AM		6.00 PM	
Thursday	7.00 AM		6.00 PM	
Friday	7.00 AM		6.00 PM	
Saturday	12.00 PM *		12.00 PM *	
Sunday	12.00 PM *		12.00 PM *	

Note: 12:00 PM = Noon
12:00 AM = Midnight

Daily Occupancy
Day time only
Day time only
Day time only
Day time only
Day time only
Day time only
Unoccupied
Unoccupied

* Programming consecutive events to the same time will cause the thermostat to choose the last event as the time at which it will set its schedule. In the above example, the thermostat will control to the unoccupied set point until 7:00 AM Monday.

Ex. #2 Commercial building which is occupied all weekend

Event	Period #1 - Event #1		Period #1 - Event #2	
	Occupied		Unoccupied	
Setpoint	Cool 72 °F	Heat 70 °F	Cool 80 °F	Heat 62 °F
Monday	8.00 AM		5.00 PM	
Tuesday	8.00 AM		5.00 PM	
Wednesday	8.00 AM		5.00 PM	
Thursday	8.00 AM		5.00 PM	
Friday	8.00 AM		5.00 PM	
Saturday	12.00 AM **		11.59 PM **	
Sunday	12.00 AM **		11.59 PM **	

Daily Occupancy
Day time only
Day time only
Day time only
Day time only
Day time only
Day time only
Occupied
Occupied

** To program a day as occupied for 24 hours, set that day Occupied time to 12:00 AM and Unoccupied time to 11:59 PM There will be a 1 minute unoccupied period every night at 11:59 PM with this schedule configuration.

G) Schedule set (4 events)

Schedule set Y/N

This section of the menu permits the user to set the whether 2 or 4 events is needed. Each day can be tailored to specific schedules if needed.

- 4 events can be programmed per day.
- Occupied & Unoccupied periods can be set for each day.
- Programming the 3 rd. & 4 th. events to the same time will cancel the last period.

Monday timer Schedule set		Tuesday timer Schedule set		Wednesday timer Schedule set		Other days are identical
Monday set? Y/N	No next → Yes down ↓	Tuesday set? Y/N	No next → Yes down ↓	Wednesda set? Y/N	No next → Yes down ↓	Selects the day to be programmed or modified
Yes key to access day scheduling, No key to jump to next day						
Occupied Day? Y/N	No next → Yes down ↓	Occupied Day? Y/N	No next → Yes down ↓	Occupied Day? Y/N	No next → Yes down ↓	Yes = Daily schedules will be accessed No = Unoccupied mode all day
Yes key to access day scheduling, No key to jump to next day						
	Copy Y/N Previous	Yes next → No down ↓	Copy Y/N Previous	Yes next → No down ↓	Yes = Will copy previous day schedule No = Daily schedules will be accessed	
Yes key to copy previous day, No key to set new time value for each day						
Occupied 00:00 AM	Use ▲▼ To set value	Occupied 00:00 AM	Use ▲▼ To set value	Occupied 00:00 AM	Use ▲▼ To set value	Sets Event # 1 Occupied time Will activate occupied setpoints
Use ▲▼ to set value, Yes key to confirm						
Unoccup 00:00 AM	Use ▲▼ To set value	Unoccup 00:00 AM	Use ▲▼ To set value	Unoccup 00:00 AM	Use ▲▼ To set value	Sets Event # 2 Unoccupied time Will activate unoccupied setpoints
Use ▲▼ to set value, Yes key to confirm						
Occupie2 00:00 AM	Use ▲▼ To set value	Occupie2 00:00 AM	Use ▲▼ To set value	Occupie2 00:00 AM	Use ▲▼ To set value	Sets Event # 3 Occupied time Will activate occupied setpoints
Use ▲▼ to set value, Yes key to confirm						
Unoccup2 00:00 AM	Use ▲▼ To set value	Unoccup2 00:00 AM	Use ▲▼ To set value	Unoccup2 00:00 AM	Use ▲▼ To set value	Sets Event # 4 Unoccupied time Will activate unoccupied setpoints
Use ▲▼ to set value, Yes key to confirm						

Ex. #1 Four event retail establishment schedule

Event	Period 1 - Event 1		Period 1 - Event 2		Period 2 - Event 3		Period 2 - Event 4		Daily Occupancy
Setpoint	Occupied		Unoccupied		Occupied		Unoccupied		
	Cool 72 °F	Heat 70 °F	Cool 80 °F	Heat 62 °F	Cool 72 °F	Heat 70 °F	Cool 80 °F	Heat 62 °F	
Monday	7.00 AM		5.00 PM		12.00 PM *		12.00 PM *		Day time only
Tuesday	7.00 AM		5.00 PM		12.00 PM *		12.00 PM *		Day time only
Wednesday	7.00 AM		5.00 PM		12.00 PM *		12.00 PM *		Day time only
Thursday	7.00 AM		5.00 PM		7.00 PM		10.30 PM		Day/evening time only
Friday	7.00 AM		5.00 PM		7.00 PM		10.30 PM		Day/evening time only
Saturday	12.00 PM *		12.00 PM *		12.00 PM *		12.00 PM *		Unoccupied
Sunday	12.00 PM *		12.00 PM *		12.00 PM *		12.00 PM *		Unoccupied

* Programming events to the same time will cancel the last period and leave the thermostat in unoccupied mode

Ex. #2 Residential

Event	Period 1 - Event 1		Period 1 - Event 2		Period 2 - Event 3		Period 2 - Event 4		Daily Occupancy
Setpoint	Occupied		Unoccupied		Occupied		Unoccupied		
	Cool 72 °F	Heat 70 °F	Cool 80 °F	Heat 62 °F	Cool 72 °F	Heat 70 °F	Cool 80 °F	Heat 62 °F	
Monday	6:00 AM		8:00 AM		4:00 PM		10:00 PM		Day/evening time only
Tuesday	6:00 AM		8:00 AM		4:00 PM		10:00 PM		Day/evening time only
Wednesday	6:00 AM		8:00 AM		4:00 PM		10:00 PM		Day/evening time only
Thursday	6:00 AM		8:00 AM		4:00 PM		10:00 PM		Day/evening time only
Friday	6:00 AM		8:00 AM		4:00 PM		11:30 PM		Day/evening time only
Saturday	8:00 AM *		8:00 AM *		8:00 AM *		11:59 PM *		Day time only
Sunday	12:00 AM *		12:00 AM *		12:00 AM *		11:59 PM *		Occupied all day

* Programming consecutive events to the same time will cause the thermostat to choose the last event as the time at which it will set its schedule. In the above example for Saturday, the thermostat will control to the occupied set point from 8:00 AM until 11:59 PM. Since it is desired to be in occupied mode throughout the night, then it is necessary to program the first event on Sunday at 12:00 AM. The thermostat will force a one minute unoccupied period for a one minute period (between 11:59 PM and 12:00 AM on Saturday)

H) Clock/Day Settings

Clock set Y/N

This section of the menu permits the user to set the time and day.

Time setting		Day setting		Time format setting	
Time set? Y/N	No next → Yes down ↓	Day set? Y/N	No next → Yes down ↓	12/24hrs set? Y/N	No = exit Yes down ↓
Time 0:00	Use ▲▼ To set value	Day Monday	Use ▲▼ To set value	12/24hrs 12 hrs	Use ▲▼ To set value

J) Schedule hold

Schedule hold Y/N

This menu

- This menu will only appear on stand-alone thermostat, e.i. without a BACnet / Echelon module.
- This section of the menu permits the user to set a permanent schedule hold, which bypasses the internal thermostat scheduling.
- The permanent schedule hold function is typically used for non-scheduled events that extend for various periods of time.
- Enabling a permanent occupied or permanent unoccupied schedule hold will cancel any active override.
- The use of temporary setpoints during permanent hold is permitted. The duration of the temporary setpoint is as set per the TOccTime parameter. Ex. 3 hours

Use ▲▼ to set value, Yes key to confirm

Schedule resume	<p>Resume regular scheduling cancels the permanent hold and re-enables the regular programming as set per internal scheduling or as per remote NSB via one of the DI's configured as remote NSB.</p> <p>This action can also be accomplished by using the Resume menu.</p> <p>Any temporary setpoint that are active will be left active for the duration of the period as set per the TOccTime parameter.</p>
Schedule occ hold	<p>Hold permanent occupied forces the thermostat into a permanent occupied mode using the occupied setpoints. All timed scheduling functions are by-passed.</p> <p>The PERMANENT OCCUPIED status will appear in the automatic status scroll. To resume to regular scheduling, user must scroll to the Schedule Hold menu and select the Schedule resume option..</p>
Schedule uno hold	<p>Hold permanent unoccupied forces the thermostat into a permanent unoccupied mode using the unoccupied setpoints. All timed scheduling functions are by-passed.</p> <p>The PERMANENT UNOCCUPIED status will appear in the automatic status scroll. To resume to regular scheduling, user must scroll to the Schedule Hold menu and select the Schedule resume option..</p>

Installer configuration parameter menu

- Configuration can be done through the network or locally at the thermostat.
- To enter configuration, press and hold the middle button “Menu” for 8 seconds
- If a password lockout is active, “Password” is prompted. Enter password value using the “up” and “down” arrows and press “Yes” to gain access to all configuration properties of the thermostat. A wrong password entered will prevent local access to the configuration menu.
- Once in the configuration menu, press the “No” button repetitively to scroll between all the available parameters.
- When the desired parameter is displayed, press “Yes” to adjust it to the desired value using “up” and “down” arrows. Once set, press “Yes” to scroll to the next parameter.

Configuration parameters	Significance Default value	Adjustments
Pswrd	Configuration parameters menu access password Default value = 0 (no password prompted)	This parameter sets a protective access password to prevent unauthorized access to the configuration menu parameters. A default value of “0” will not prompt a password or lock the access to the configuration menu. Range is: 0 to 1000
Com addr	Thermostat networking address Default value = 254 Range is: 0 to 254	Conditional parameter to BACnet MS-TP models (VT76xxX5x28B) Conditional parameter to Wireless models (VT76xxX5x28W) This parameter will only appear when a BACnet or wireless network adapter is present. If the thermostat is installed as a stand-alone unit or with an Echelon adapter, this parameter will not be used or displayed <ul style="list-style-type: none"> - For BACnet MS-TP models valid range to use is from 1 to 127. Default value of 254 disables BACnet communication for the thermostat. - For wireless models valid range is 0 to 254 with a maximum of 30 thermostat per VWG
PAN ID	Personal Area Network Identification Default value = 0 Range is: 0 to 500	Conditional parameter to Wireless models (VT76xxX5x28W) This parameter will only appear when a wireless network adapter is present. If the thermostat is installed as a stand-alone unit or with a BACnet or Echelon adapter, this parameter will not be used or displayed This parameter (Personal Area Network Identification) is used to link specific thermostats to a single specific Vykon JACE with wireless network adapter. For every thermostat reporting to a JACE (maximum of 30 wireless thermostats), be sure you set the SAME PAN ID value both at the JACE and the thermostat(s). The default value of 0 is NOT a valid PAN ID. The valid range of available PAN ID is from 1 to 500

Channel	<p>Channel selection</p> <p>Default value = 10</p> <p>Range is: 10 to 26</p>	<p>Conditional parameter to Wireless models (VT76xxX5x28W) This parameter will only appear when a wireless network adapter is present. If the thermostat is installed as a stand-alone unit or with a BACnet or Echelon adapter, this parameter will not be used or displayed</p> <p>This parameter (Channel) is used to link specific thermostats to a specific Vykon JACE with wireless network adapter. For every thermostat reporting to a JACE (maximum of 30 wireless thermostats), be sure you set the SAME channel value both at the JACE and the thermostat(s).</p> <p>Vykon recommends using only the 2 last channels (25-2575MHz and 26-2580MHz)</p> <p>The default value of 10 is NOT a valid channel. The valid range of available channel is from 11 to 26</p>
DI 1	<p>Digital input no.1 configuration</p> <p>Open contact input = function not energized</p> <p>Closed contact input = function energized</p> <p>Default value = None</p>	<p>None, No function will be associated with the input</p> <p>Rem NSB, remote NSB timer clock input. Will disable the internal scheduling of the thermostat. The scheduling will now be set as per the digital input. The time is still displayed as information, but the menu part related to scheduling is disabled and no longer accessible.</p> <p>Open contact = occupied setpoints Closed contacts = unoccupied setpoints</p> <p>RemOVR Temporary override remote contact. Disables all override menu function of the thermostat. The override function is now controlled by a manual remote momentarily closed contact. When configured in this mode, the input operates in a toggle mode. With this function enabled it is now possible to toggle between unoccupied & occupied setpoints for the amount of time set by parameter (TOccTime) temporary occupancy time. When Override is enabled, an Override status message will be displayed</p> <p>Filter, a back-lit flashing Filter alarm will be displayed on the thermostat LCD screen when the input is energized</p> <p>Service, a back-lit flashing Service alarm will be displayed on the thermostat LCD screen when the input is energized</p> <p>Fan lock, a back-lit flashing Fan lock alarm will be displayed on the thermostat LCD screen when the input is not energized. Used in conjunction with a local airflow sensor connected to the input. Locks out the thermostat heating and cooling action if no airflow is detected 10 seconds after the fan (G terminal) is energized.</p> <p>Open contact = no airflow Closed contacts = airflow present</p>
DI 2	<p>Digital input no. 2 configuration</p> <p>Default value = None</p>	<p>Same as above. It is possible to configure both inputs to have the same function.</p>
MenuScro	<p>Menu scroll</p> <p>Default value = On = Scroll active</p>	<p>Removes the scrolling display and only present the room temperature/humidity to the user. With this option enabled, no status is given of mode, schedule and outdoor temperature.</p> <p>On = Scroll active Off = Scroll not active</p>

lockout	Keypad lockout levels Default value = 0 No lock				0 = No lock 1 = Low level 2 = High level																											
Level	Resume/ Override scheduling	Permanent Occupied and Unoccupied Setpoints	Temporary setpoints using arrows	System mode setting	Fan mode setting	Schedules setting	Clock setting	Permanent hold																								
	Resume sched Y/N	RoomTemp set Y/N	Up key (▲) Down key (▼)	Sys mode set Y/N	Fan mode set Y/N	Schedule set Y/N	Clock set Y/N	Schedule hold Y/N																								
0	Yes access	Yes access	Yes access	Yes access	Yes access	Yes access	Yes access	Yes access																								
1	Yes access	No access	Yes access	No access	No access	No access	Yes access	No access																								
2	No access	No access	No access	No access	No access	No access	Yes access	No access																								
pwr del	Power-up delay Default value = 10 seconds				On initial power up of the thermostat (each time 24 Vac power supply is removed & re-applied) there is a delay before any operation is authorized (fan, cooling or heating). This can be used to sequence start up multiple units / thermostat in one location. 10 to 120 seconds																											
Frost pr	Frost protection enabled Default value = Off On heat pump models the system mode will be forced to EMERGENCY mode if frost protection is activated				Off: no room frost protection On: room frost protection enabled in all system mode at: 42 °F (5.6 °C) Frost protection is enabled even in system Off mode Off or On																											
heat max	Maximum heating setpoint limit Default value = 90 °F (32 °C)				Maximum occupied & unoccupied heating setpoint adjustment. Heating setpoint range is: 40 to 90 °F (4.5 to 32.0 °C)																											
cool min	Minimum cooling setpoint limit Default value = 54 °F (12 °C)				Minimum occupied & unoccupied cooling setpoint adjustment. Cooling setpoint range is: 54 to 100 °F (12.0 to 37.5 °C)																											
Pband	Proportional Band setting Default value = 2.0 °F (0.6 °C)				Adjust the proportional band used by the thermostat PI control loop. Warning. Note that the default value of 2.0 °F (0.6 °C) gives satisfactory operation in most normal installation cases. The use of a superior proportional band different than the factory one is normally warranted in applications where the thermostat location is problematic and leads to unwanted cycling of the unit. A typical example is a wall mounted unit where the thermostat is installed between the return and supply air feeds and is directly influenced by the supply air stream of the unit.																											
					<table border="1"> <thead> <tr> <th>Value</th> <th>F scale Pband</th> <th>C scale Pband</th> </tr> </thead> <tbody> <tr> <td>2</td> <td>2 F</td> <td>0.6 C</td> </tr> <tr> <td>3</td> <td>3 F</td> <td>1.2 C</td> </tr> <tr> <td>4</td> <td>4 F</td> <td>1.7 C</td> </tr> <tr> <td>5</td> <td>5 F</td> <td>2.2 C</td> </tr> <tr> <td>6</td> <td>6 F</td> <td>2.8 C</td> </tr> <tr> <td>7</td> <td>7 F</td> <td>3.3 C</td> </tr> <tr> <td>8</td> <td>8 F</td> <td>3.9 C</td> </tr> </tbody> </table>				Value	F scale Pband	C scale Pband	2	2 F	0.6 C	3	3 F	1.2 C	4	4 F	1.7 C	5	5 F	2.2 C	6	6 F	2.8 C	7	7 F	3.3 C	8	8 F	3.9 C
Value	F scale Pband	C scale Pband																														
2	2 F	0.6 C																														
3	3 F	1.2 C																														
4	4 F	1.7 C																														
5	5 F	2.2 C																														
6	6 F	2.8 C																														
7	7 F	3.3 C																														
8	8 F	3.9 C																														
Anticycle	Minimum on/off operation time for stages Default value = 2 minutes Anti-short cycling can be set to 0 minutes for equipment that posses their own anti cycling timer. Do not use that value unless the equipment is equipped with such internal timer. Failure to do so can damage the equipment.				Minimum On/Off operation time of cooling & heating stages. IMPORTANT, anti-short cycling can be set to 0 minutes for equipment that posses their own anti cycling timer. Do not use this value unless the equipment is equipped with such internal timer. Failure to do so can damage the equipment. 0, 1, 2, 3, 4 & 5 minutes																											

Heat cph	Heating stages cycles per hour Default value = 4 C.P.H. For multi stage models, heat cph applies to W1 & W2 For heat pump models, heat cph applies to W1 only (Emergency heat)	Will set the maximum number of heating stage cycles per hour under normal control operation. It represents the maximum number of cycles that the equipment will turn ON and OFF in one hour. Note that a higher C.P.H will represent a higher accuracy of control at the expense of wearing mechanical components faster. 3, 4, 5, 6,7 & 8 C.P.H.
cool cph	Cooling stages cycles per hour Default value = 4 C.P.H. For multi stage models, cool cph applies to Y1 & Y2 For heat pump models, cool cph applies to Y1 & Y2 in cooling and heating independently of the reversing valve position	Will set the maximum number of cooling stage cycles per hour under normal control operation. It represents the maximum number of cycles that the equipment will turned on and off in one hour. Note that a higher C.P.H will represent a higher accuracy of control at the expense of wearing mechanical components faster. 3 or 4 C.P.H.
Deadband	Minimum deadband Default value = 2.0 °F (1.1 °C)	Minimum deadband value between the heating and cooling setpoints. If modified, it will be applied only when any of the setpoints are modified. 2, 3 or 4 °F (1.0 to 2.0 °C)
fan cont	Fan control Default value = On For multi stage models, fan control applies to W1 & W2 For heat pump models, fan control applies to W1 only (Emergency heat)	Fan control in heating mode. When selecting On ; the thermostat in all cases will always control the fan (terminal G). Valid for On or Auto fan mode When selecting Off ; the fan (terminal G), when heating stages (terminals W1 & W2) are solicited, will not be energized. The fan in this case will be controlled by the equipment fan limit control. Valid only for Auto fan mode. On fan mode will leave the fan always on. On or Off
fan del	Fan delay Default value = Off	Fan delay extends fan operation by 60 seconds after the call for heating or cooling ends. Valid only for Auto fan mode. "On" fan mode will leave the fan always on. Off or On
ToccTime	Temporary occupancy time Default value = 3 hours	Temporary occupancy time with occupied mode setpoints when override function is enabled When the thermostat is in unoccupied mode, function is enabled with either the menu or DI1 or DI2 configured as remote override input. 0,1, 2, 3, 4, 5, 6, 7, 8, 9, 10, 11 & 12 hours
cal RS	Room air temperature sensor calibration Default value = 0.0 °F or °C	Offset that can be added/subtracted to actual displayed room temperature ± 5.0 °F (± 2.5 °C)
cal OS	Outside air temperature sensor calibration Default value = 0.0 °F or °C	Offset that can be added/subtracted to actual displayed outside air temperature ± 5.0 °F (± 2.5 °C)
H stage	Number of heating stages. Applicable to 2 stage models only Default value = 2 stages For heat pump models, H stage is limited to 1 stage only (W1 – Aux. Heat)	Will revert the operation of 2 stages thermostat to single stage operation only when the second heating step is not needed. 1 or 2 stages

C stage Or HP stage	Number of cooling stages 2 stages model only Default value = 2 stages For heat pump models, HP stage selects the number of compressor stages	Will revert the operation of 2 stage thermostat to single stage operation only when the second cooling step is not needed. 1 or 2 stages									
H lock	Outside air temperature heating lockout Default value = 120 °F (49 °C)	Disables heating stage operation based on outdoor air temperature. Function will only be enabled if OS (outside air temperature sensor) is connected. From -15 °F up to 120 °F (-26 °C up to 49 °C)									
C lock	Outside air temperature mechanical cooling lockout. Default value = -40 °F (-40 °C)	Disables cooling stage operation based on outdoor air temperature. On economizer model, free cooling will not be disabled by this function. Function will only be enabled if OS (outside air temperature sensor) is connected. From -40 °F up to 95 °F (-40 °C up to 35 °C)									
Unocc TM	Unoccupied Timer value Default 0.5 hours	Time delay between the moment where the thermostat toggles from occupied to unoccupied after the last movement has been detected by the PIR. Range is: 0.5 to 24.0 hours in 0.5 hour increments									
2/4event	Number of events configuration Default value = 2 event	2 events , will set up programming for the following Event 1 is for Occupied setpoints Event 2 is for Unoccupied setpoints 4 events , will set up programming for the following Event 1 is for Occupied setpoints Event 2 is for Unoccupied setpoints Event 3 is for Occupied setpoints Event 4 is for Unoccupied setpoints									
aux cont	Auxiliary contact configuration Default value = N.O. normally open	This contact can be used to energize peripheral devices such as: lighting equipment, exhaust fans, economizers, etc. This contact will operate in parallel with the internal occupied/unoccupied schedule of the thermostat or the remote NSB contact if DI1 or DI2 is used. When the system is in OFF mode , the contact will remain in its unoccupied status independently of the occupied / unoccupied schedule. <table border="1" data-bbox="777 1486 1507 1596"> <thead> <tr> <th>Configured</th> <th>Contact occupied status</th> <th>Contact unoccupied status</th> </tr> </thead> <tbody> <tr> <td>N.O.</td> <td>Closed</td> <td>Opened</td> </tr> <tr> <td>N.C.</td> <td>opened</td> <td>Closed</td> </tr> </tbody> </table>	Configured	Contact occupied status	Contact unoccupied status	N.O.	Closed	Opened	N.C.	opened	Closed
Configured	Contact occupied status	Contact unoccupied status									
N.O.	Closed	Opened									
N.C.	opened	Closed									

Prog rec	Progressive recovery enabled Default value = Off Progressive recovery is automatically disabled if DI 1 and / or DI 2 are configured remote NSB	Off , = no progressive recovery The programmed occupied schedule time is the time at which the system will restart. On , = progressive recovery active. The programmed occupied schedule time is the time at which the desired occupied temperature will be attained. The thermostat will automatically optimize the equipment start time. In any case, the latest a system will restart is 10 minutes prior to the occupied period time.
Heat Pump models only		
high bp	High balance point Default value = 90 °F (32.0 °C) Function will only be enabled if OS (outside air temperature sensor) is connected.	In <i>Heating or Auto mode</i> , it is the outside air temperature value at which the auxiliary heat will be cut off. Above that value, only the heat pump will be used to maintain the heating setpoint 34 to 90 °F (1.0 to 32.0 °C)
low bp	Low balance point Default value = -12 °F (-24 °C) Function will only be enabled if OS (outside air temperature sensor) is connected.	In <i>Heating, Cooling or Auto mode</i> , it is the outside air temperature value at which the heat pump operation will be cut off. Below that value, only the auxiliary heat will be used to maintain the heating setpoint -40 to 30 °F (-40 to -1.0 °C)
Comf/eco	Comfort or economy mode Default value = Comfort	Sets the operation and interaction mode of the heat pump with the auxiliary heat. Comfort mode. In <i>Heating mode</i> . If the heat pump is not able to satisfy the heating setpoint, the auxiliary heat will be energized to satisfy the same heating setpoint. Economy mode. In <i>Heating mode</i> . If the heat pump is not able to satisfy the heating setpoint, the auxiliary heat will be energized to satisfy only when the temperature has dropped 2.0 °F (1.1 °C) below the heating setpoint. Selecting economy mode will add a deadband between the heatpump & auxiliary heat in heating mode. The actual temperature maintained will be lower than the true heating setpoint to maximize the heat pump operation. When the outdoor air temperature drops below the <i>low balance point</i> , the deadband will be eliminated and the auxiliary heat will maintain the true heating setpoint alone. Economy mode. In <i>Emergency mode</i> . If <i>Emergency heat mode</i> is selected, the setpoint maintained, will be the heating setpoint.
re valve	Reversing valve operation O/B Default value = O	Heat pump reversing valve operation O will energize the valve in cooling operation. B will energize the valve in heating operation O or B

comp/aux	Compressor/auxiliary interlock Default value = Off	Sets the operation and interaction mode of the heat pump with the auxiliary heat. Interlock Off. In <i>Heating mode</i> . If the heat pump is not able to satisfy the heating setpoint, the auxiliary heat will be energized at the same time as the heat pump stage. Typically applies when the air handler heat pump coil is installed before the auxiliary heat. (all electric systems) Interlock On. In <i>Heating mode</i> . If the heat pump is not able to satisfy the heating setpoint, the auxiliary heat will be energized and the heat pump will be cut off. Typically applies when the air handler heat pump coil is installed after the auxiliary heat. (add on systems) There is a 2 minute delay to restart the heat pump, when the auxiliary heat is shut down Off or On
-----------------	--	--

Notes for Heat Pump models: When the outside air sensor is not connected or is shorted, the thermostat bypasses the heating / cooling lockouts and the low / high balance points. Also Heat Pump model when set in Emergency system mode bypasses heating lockout and permits auxiliary heating whenever a heating demand occurs.

Economizer Model only																										
Chngstpt	Changeover setpoint Default value = 55 °F (13.0 °C)	In <i>Cooling mode</i> . The outside air temperature value at which the cooling will be switched over from mechanical (compressor) to free cooling (economizer) 14 to 70 °F (-10.0 to 21.0 °C)																								
min pos	Minimum position Default value = 0%	Outside air damper minimum position. Will be active only when fan is on (G terminal) and the internal or remote scheduling is in occupied mode. When internal or remote scheduling is in unoccupied mode and/or fan is off, minimum position will be set to 0% 0 to 100 % = 0 to 10 Vdc output range <table border="1" data-bbox="867 1167 1312 1318"> <thead> <tr> <th>Outside air percentage</th> <th>0%</th> <th>5%</th> <th>10%</th> <th>15%</th> <th>20%</th> <th>25%</th> <th>30%</th> </tr> </thead> <tbody> <tr> <td>Setting for 0-10 Vdc Actuator</td> <td>0%</td> <td>5%</td> <td>10%</td> <td>15%</td> <td>20%</td> <td>25%</td> <td>30%</td> </tr> <tr> <td>Setting for 2-10 Vdc Actuator</td> <td>0 to 20%</td> <td>24%</td> <td>28%</td> <td>32%</td> <td>36%</td> <td>40%</td> <td>44%</td> </tr> </tbody> </table>	Outside air percentage	0%	5%	10%	15%	20%	25%	30%	Setting for 0-10 Vdc Actuator	0%	5%	10%	15%	20%	25%	30%	Setting for 2-10 Vdc Actuator	0 to 20%	24%	28%	32%	36%	40%	44%
Outside air percentage	0%	5%	10%	15%	20%	25%	30%																			
Setting for 0-10 Vdc Actuator	0%	5%	10%	15%	20%	25%	30%																			
Setting for 2-10 Vdc Actuator	0 to 20%	24%	28%	32%	36%	40%	44%																			
C mech	Mechanical cooling allowed Default value = Off	In <i>Cooling mode</i> . Allows the operation of the mechanical cooling if the free cooling (economizer) cannot maintain the cooling setpoint. Off Typically applies when the MS (mixed air temperature sensor) is installed after the mechanical cooling refrigeration coils. In this case, mechanical cooling will never operate at the same time as free cooling. On Typically applies when the MS (mixed air temperature sensor) is installed before the mechanical cooling refrigeration coils in the mixing plenum. In this case, mechanical cooling is allowed when the free cooling (economizer operation) cannot maintain the cooling setpoint. Off or On																								
mix stpt	Mixed air setpoint Default value = 55 °F (13.0 °C)	Free cooling mixed air setpoint when economizer mode is enabled. 50 to 90 °F (10.0 to 32.0 °C)																								
MS dis	Display mixed air temperature Economizer model only, only if sensor is installed	Used as diagnostic / service help to troubleshoot and diagnose economizer operation.																								

Troubleshooting guide

All models

Symptom	Possible Cause	Corrective Action
No display on the thermostat	Absent or incorrect supply voltage	1. Check power supply voltage between C & RC to be from 19-30 Vac 2. Check for tripped fuse or circuit breaker
	Overloaded power transformer	Verify that the transformer used is powerful enough (enough VA's) to supply all controlled devices including the thermostat
Keyboard menu does not access all functions	Keyboard locked	Change configuration parameter LOCKOUT to value "0" to access all levels of the menu
Temperature setpoints revert to original value after a certain time period	Temporary setpoint option selected	1. The thermostat needs to be in Permanent setpoint mode for the new setpoint to be kept and memory and used all the time 2. Go to the Set temperature menu. 3. The last prompt is setpoint type. Set it to Permanent setpoint
Thermostat will not call for heating	Wrong mode selected	Select heating mode
	Thermostat in Unoccupied mode	Select Occupied Hold in Schedule hold or Override to force the thermostat Occupied heating setpoint
	Anticycle delay active	Wait, the anticycling period will end and the equipment will start
	Heating setpoint is satisfied	Raise the Heating setpoint
	Heating lockout attained	1. Mode is locked out based on outside air temperature 2. Change configuration parameter H Lock to value 120 °F (49 °C) to by-pass lockout
	Wiring error	1. Start the Fan by forcing the Fan ON mode 2. Put a jumper across terminals RH & W1. The heating should come ON. If it does not, verify wiring and check if a jumper is required between RC & RH
Thermostat will not call for cooling	Wrong mode selected	Select cooling mode
	Thermostat in Unoccupied mode	Select Occupied Hold in Schedule hold or Override to force the thermostat Occupied cooling setpoint
	Anticycle delay active	Wait, the anticycling period will end and the equipment will start
	Cooling setpoint is satisfied	Lower the cooling setpoint
	Cooling lockout attained	1. Mode is locked out based on outside air temperature 2. Change configuration parameter C Lock to value - 40 °F (-40 °C) to by-pass lockout
	Wiring error	1. Start the Fan by forcing the Fan ON mode 2. Put a jumper across terminals RC & Y1. The cooling should come ON. If it does not, verify wiring
The thermostat will not turn on the fan	Wrong mode selected	1. Start the Fan by forcing the Fan ON mode 2. Put a jumper across terminals RC & G. The fan should come ON. If it does not, verify wiring
	Wiring error	
Digital display shows missing digits or erratic segments	Defective display	Replace thermostat

Troubleshooting guide

Heatpump models

Auxiliary heat does not operate	Wrong mode selected	Select emergency heat mode
	Thermostat in Unoccupied mode	Select Occupied Hold in Schedule hold or Override to force the thermostat Occupied heating setpoint
	Anticycle delay active	Wait, the anticycling period will end and the equipment will start
	Heating setpoint is satisfied	Raise the Heating setpoint
	High Balance point attained	1. Mode is locked out based on outside air temperature 2. Change configuration parameter High BP to value 90 °F (32 °C) to by-pass lockout
	Heating lockout attained	1. Mode is locked out based on outside air temperature 2. Change configuration parameter H Lock to value 120 °F (49 °C) to by-pass lockout
	Wiring error	1. Start the Fan by forcing the Fan ON mode 2. Put a jumper across terminals RH & W1. The heating should come ON. If it does not, verify wiring and check if a jumper is required between RC & RH
Heat pump does not operate in heating mode	Wrong mode selected	Select heating mode
	Thermostat in Unoccupied mode	Select Occupied Hold in Schedule hold or Override to force the thermostat Occupied heating setpoint
	Anticycle delay active	Wait, the anticycling period will end and the equipment will start
	Heating setpoint is satisfied	Raise the Heating setpoint
	Low Balance point attained	1. Mode is locked out based on outside air temperature 2. Change configuration parameter Low BP to value - 12 °F (-24 °C) to by-pass lockout
	Heating lockout attained	1. Mode is locked out based on outside air temperature 2. Change configuration parameter H Lock to value 120 °F (49 °C) to by-pass lockout
	Wiring error	1. Start the Fan by forcing the Fan ON mode 2. Put a jumper across terminals RH & W1. The heating should come ON. If it does not, verify wiring and check if a jumper is required between RC & RH
	Wrong reversing valve configuration	1. Wrong selection of parameter Re Valve 2. Select O will energize the valve in cooling operation. Valve is normally heat. 3. Select B will energize the valve in heating operation. Valve is normally cool.

Specifications

Thermostat power requirements:	19-30 Vac 50 or 60 Hz; 2 VA (RC & C) Class 2 RC to RH jumper 2.0 Amps 48 VA maximum
Operating conditions:	0 °C to 50 °C (32 °F to 122 °F) 0% to 95% R.H. non-condensing
Storage conditions:	-30 °C to 50 °C (-22 °F to 122 °F) 0% to 95% R.H. non-condensing
Sensor:	Local 10 K NTC thermistor
Resolution:	± 0.1 °C (± 0.2 °F)
Control accuracy:	± 0.5 °C (± 0.9 °F) @ 21 °C (70 °F) typical calibrated
Occupied and unoccupied setpoint range cooling:	12.0 to 37.5 °C (54 to 100 °F)
Occupied and unoccupied setpoint range heating:	4.5 °C to 32 °C (40 °F to 90 °F)
Room and outdoor air temperature range	-40 °C to 50 °C (-40 °F to 122 °F)
Proportional band for room temperature control:	Factory set, heating and cooling at: 1.1°C (2.0°F)
Digital inputs:	Relay dry contact only across C terminal to DI1 or DI2
Contact output rating:	Each relay output: (Y1, Y2, G, W1, W2 & AU) 30 Vac, 1 Amp. maximum 30 Vac, 3 Amp. in-rush
Economizer analog output rating:	0 to 10 Vdc into 2KΩ resistance min.
Economizer analog output accuracy:	± 3% typical
Wire gauge	18 gauge maximum, 22 gauge recommended
Dimensions:	4.94" x 3.38" x 1.13"
Approximate shipping weight:	0.75 lb (0.34 kg)
Agency Approvals all models:	UL: UL 873 (US) and CSA C22.2 No. 24 (Canada), File E27734 with CCN XAPX (US) and XAPX7 (Canada) Industry Canada: ICES-003 (Canada) FCC: Compliant to CFR 47, Part 15, Subpart B, Class A (US) CE: EMC Directive 89/336/EEC (Europe Union) C-Tick: AS/NZS CISPR 22 Compliant (Australia / New Zealand) Supplier Code Number N10696
Agency Approvals all models	FCC: Compliant to: Part 15, Subpart C
Agency Approvals Wireless models	

THIS DEVICE COMPLIES WITH PART 15 OF THE FCC RULES. OPERATION IS SUBJECT TO THE FOLLOWING TWO CONDITIONS: (1) THIS DEVICE MAY NOT CAUSE HARMFUL INTERFERENCE, AND (2) THIS DEVICE MUST ACCEPT ANY INTERFERENCE RECEIVED, INCLUDING INTERFERENCE THAT MAY CAUSE UNDESIRE OPERATION.

Drawing & dimensions

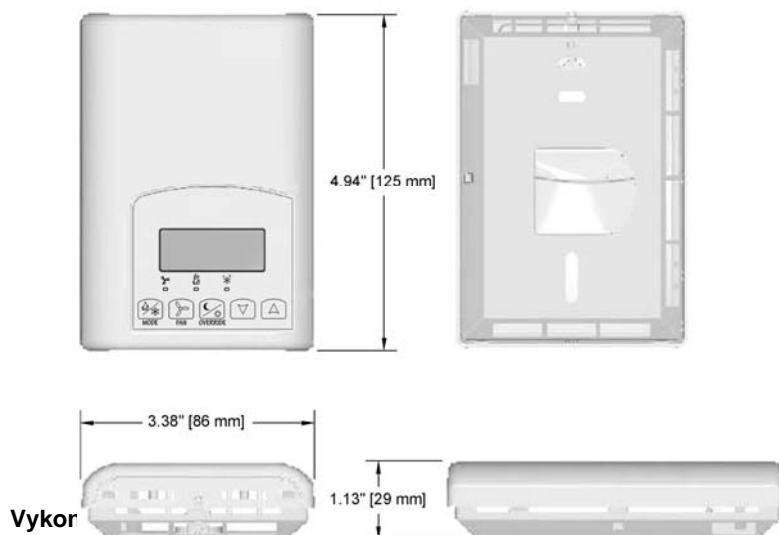

Important Notice



⚠ VT7600 series controls are use as operating controls only and are not safety devices. These instruments have undergone rigorous tests and verifications prior to shipment to ensure proper and reliable operation in the field. Whenever a control failure could lead to personal injury and/or loss of property, it becomes the responsibility of the user / installer / electrical system designer to incorporate safety devices (such as relays, flow switch, thermal protections, etc...) and/or alarm system to protect the entire system against such catastrophic failures. Tampering of the devices or miss application of the device will void warranty.

The Waste Electrical and Electronic Equipment (WEEE) mark applies only to countries within the European Union (EU) and Norway. Electric/Electronic devices are labeled in accordance with European Directive 2002/96/EC concerning waste electrical and electronic equipment (WEEE). The Directive determines the framework for the return and recycling of used Electric/Electronic devices at the end of life within and throughout the European Union (EU). This label is applied to various products to indicate the product is not to be thrown away, but rather be reclaimed upon the end of the products useful life per this directive.

Users of electric and electronic equipment with the WEEE marking per annex IV of the WEEE Directive must not dispose of end of life Electric/Electronic waste as unsorted municipal waste, but rather use the collection framework available to them for the return, recycle and recovery of WEEE and minimize the environmental impact of Electric/Electronic waste due to the presence of hazardous substance.

For additional information please go to: www.Vykon.com